

# MB-11-BK

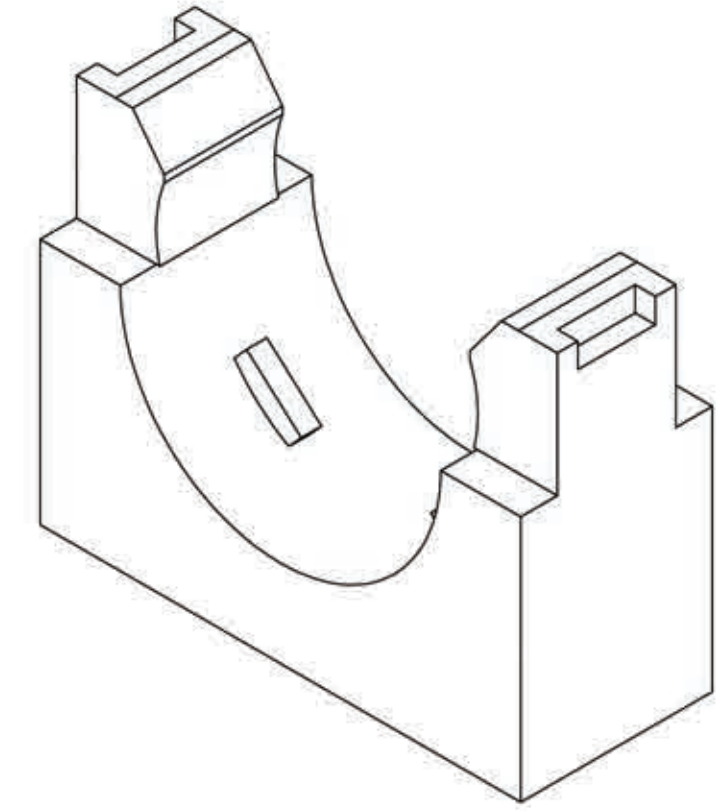
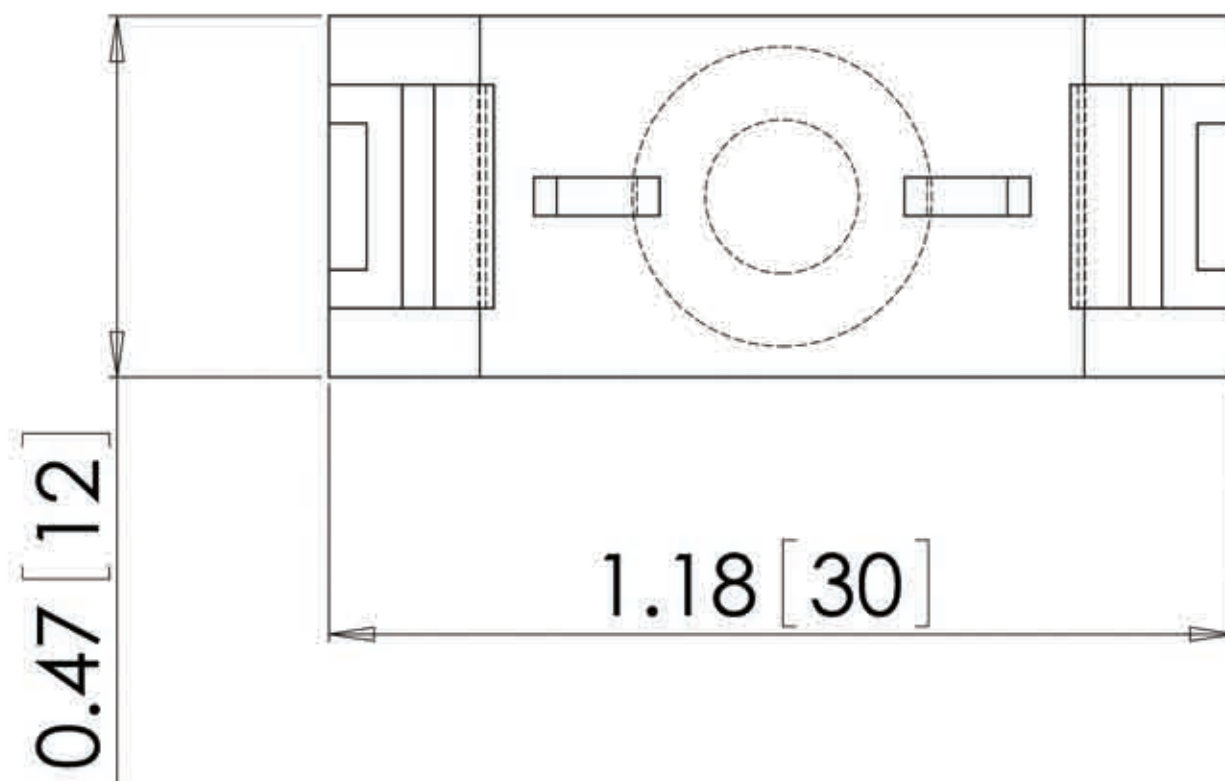
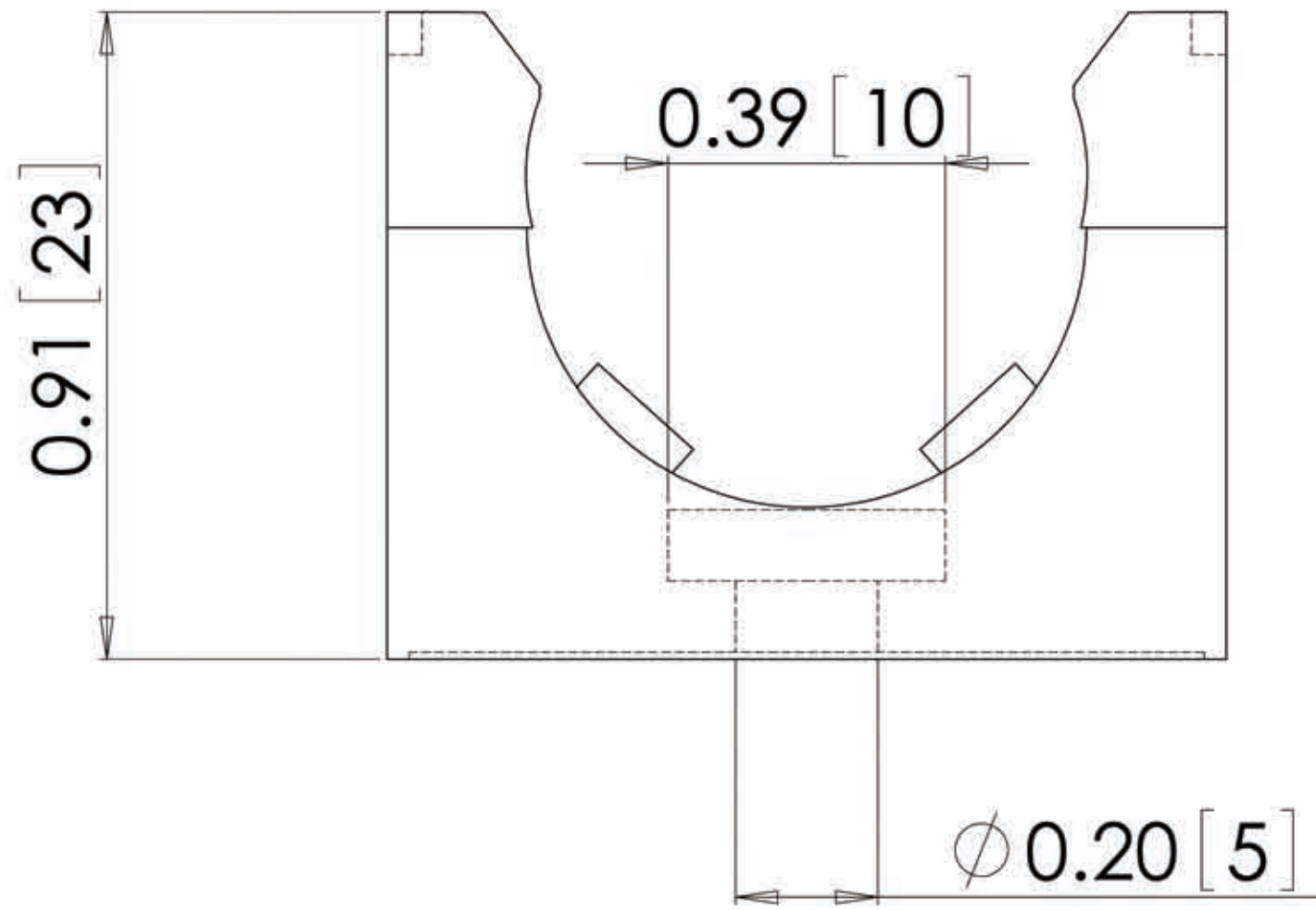

## NOTES:

- 1) GENERAL DIMENSIONS DRAWINGS.
- 2) DIMENSIONS [ ] ARE IN MILLIMETER.
- 3) DIMENSIONS NOTED ARE FOR REFERENCE ONLY.

Third angle projection

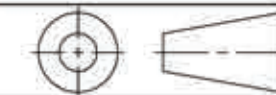

**SEALCON**

7374 S. EAGLE STREET  
CENTENNIAL, CO 80112-4221 USA  
TOLL FREE: 1-800-456-9012  
PHONE: 303-699-1135  
EMAIL: [info@SealconUSA.com](mailto:info@SealconUSA.com)  
WEBSITE: [www.SealconUSA.com](http://www.SealconUSA.com)

