

MB-36-BK

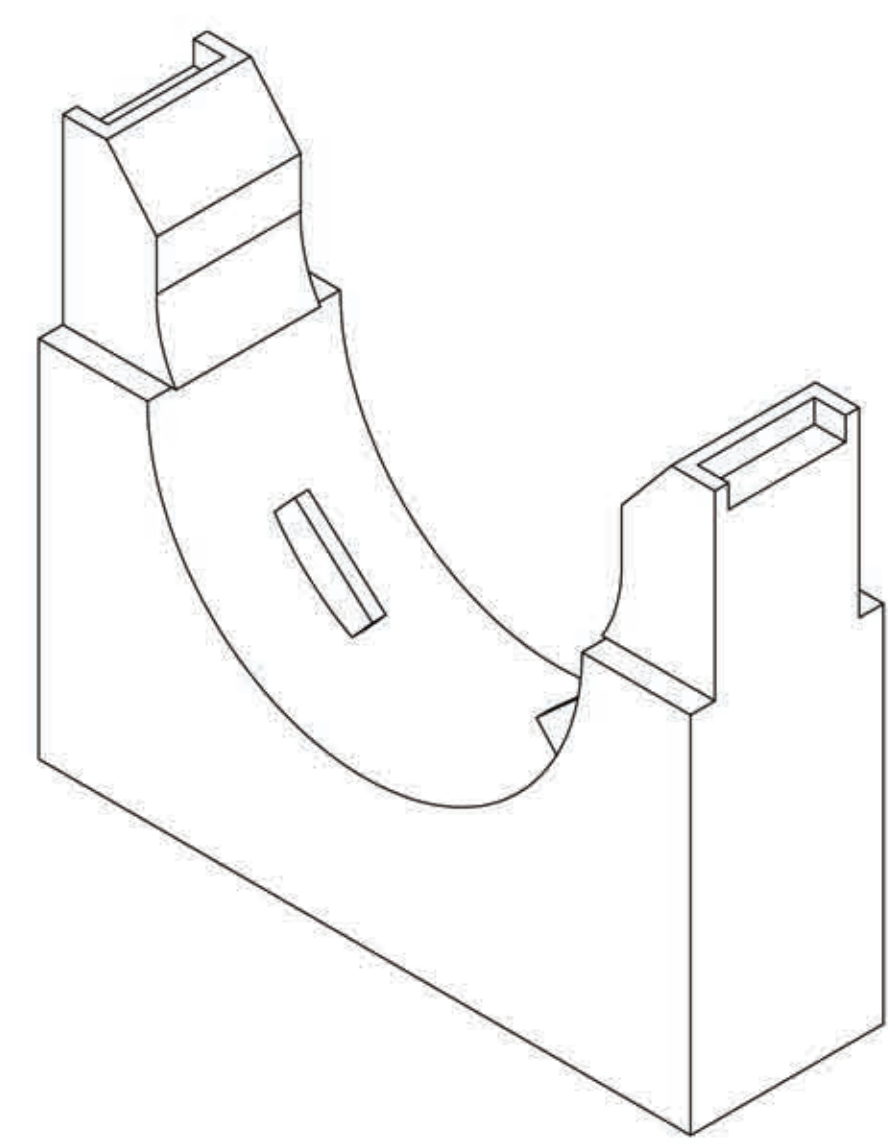
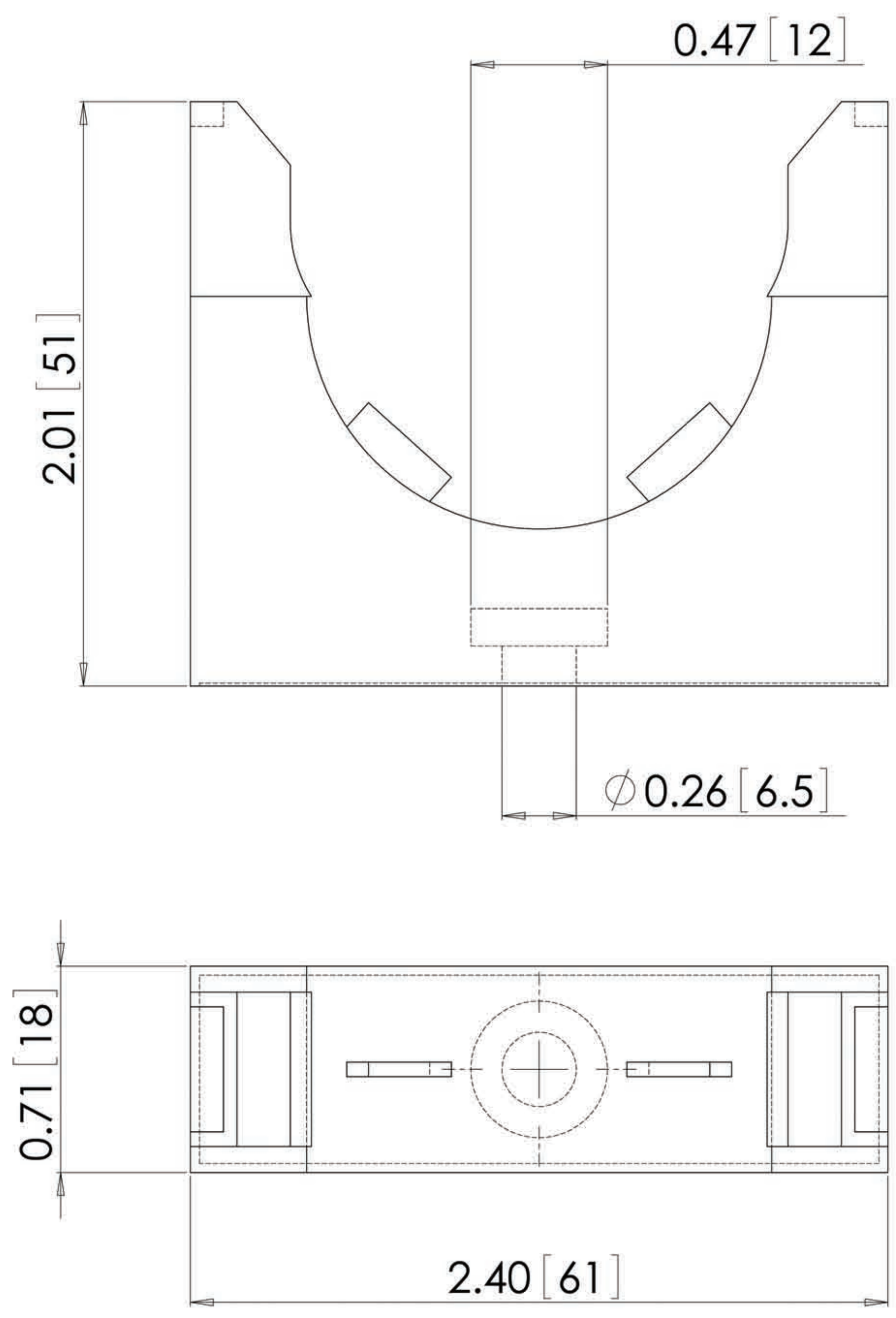

NOTES:

- 1) GENERAL DIMENSIONS DRAWINGS.
- 2) DIMENSIONS [] ARE IN MILLIMETER.
- 3) DIMENSIONS NOTED ARE FOR REFERENCE ONLY.

Third angle projection		
7374 S. EAGLE STREET CENTENNIAL, CO 80112-4221 USA TOLL FREE: 1-800-456-9012 PHONE: 303-699-1135 EMAIL: info@SealconUSA.com WEBSITE: www.SealconUSA.com		